

---

**"DMTech" Ltd. Pleven**

**Extinguishing Control Panel**

**FP9000E**

**INSTALLATION**

**AND OPERATION MANUAL**

Rev 04:19



**P. CONTENTS:**

|           |  |
|-----------|--|
| <b>2</b>  | <b>INTRODUCTION</b>  |
| <b>3</b>  | <b>TECHNICAL PARAMETERS</b>                                  |
| <b>6</b>  | <b>CONTROLS AND INDICATION</b>                               |
| <b>8</b>  | <b>DEFAULT PARAMETERS</b>                                    |
| <b>8</b>  | <b>INSTALLATION AND PANEL SETUP</b>                          |
| <b>14</b> | <b>ACCESS LEVELS</b>   |
| <b>15</b> | <b>OPERATION MODES</b>                                       |
| <b>18</b> | <b>INFORMATION AND CONTROL CONDITION</b>                     |
| <b>19</b> | <b>DELIVEERY COMPOSITION AND COMPLEXITY/SET AND WARRANTY</b> |

**1. INTRODUCTION**

FP9000E is a conventional fire extinguishing control panel. The panel is designed for using together with systems for gas, powder, aerosol, water and other types of active extinguishing.

FP9000E has 3 zones - 2 extinguishing with activation of automatic fire detectors and 1 conventional fire zone. Automatic and manual operation modes (selectable via 3 positional key lock) allow the operators to choose the extinguishing process control.

The FP9000E conventional panel is designed for extinguishing in one zone and can operate with solenoids, pressostats and other kind of actuators.

Each fire line can be connected to 32 detectors. Through the display and keyboard can be programmed and adjusted over 50 functional parameters. Each line has 5 individual programmable parameters and that makes the panel universal for any type of conventional Fire detectors. All the panel conditions information is displayed on LCD 2x16 display and LED indicators. Volatile memory and real time clock enable recording and review of 1600 archive events.

**Quick and easy - installation, setup and starting. Simple and clear procedures for operation and maintenance of the system.**

## 2. TECHNICAL PARAMETERS

| <b>Fire LINES</b>   |                         |                                 |
|---|-------------------------|---------------------------------|
| <b>➤ Lines:</b>   |                         |                                 |
| • Extinguishing–2 fixed lines (Line 1 and Line 2)   | <b>2</b>                |                                 |
| • Fire Alarm – 1 fixed line (Line 3)  | <b>1</b>                |                                 |
| • Maximum number of fire detectors in a line  | <b>32</b>               |                                 |
| • Type of the joining line  | <b>biconductional</b>   |                                 |
| • Plume maximum resistance  | <b>100 Ω</b>            |                                 |
| <b>➤ Current thresholds in the lines:</b>   |                         |                                 |
| • Interruption  | <b>from 1 to 12 mA</b>  | <b>programmable</b>             |
| • Duty mode   | <b>from 2 to 60 mA</b>  | <b>programmable</b>             |
| • Fire  | <b>from 12 to 99 mA</b> | <b>programmable</b>             |
| • Short circuit   | <b>&gt; 100 mA</b>      |                                 |
| <b>➤ Lines functional characteristics:</b>  |                         |                                 |
| • Verification quantity before entering Fire mode:  | <b>1, 2 or 3</b>        | <b>programmable</b>             |
| • Verification and registering fault in a earth conductor   | <b>yes</b>              | <b>selectively programmable</b> |
| <b>Supervised balanced inputs</b>   |                         |                                 |
| <b>➤ Manual Release:</b>  |                         |                                 |
| • The “Manual Release” input is normally open.  | <b>1</b>                |                                 |
| <b>➤ Hold:</b>  |                         |                                 |
| • The “Hold” input can be configured:<br># input is normally open;<br># input is normally closed.       | <b>1</b>                | <b>selectively programmable</b> |
| <b>➤ Low Press.:</b>  |                         |                                 |
| • The “Low Press.” input can be configured:<br># input is normally open;<br># input is normally closed. | <b>1</b>                | <b>selectively programmable</b> |
| <b>➤ Mode Select:</b>   |                         |                                 |
| • The “Mode Select” input is normally open.   | <b>1</b>                |                                 |
| <b>➤ On/Off Exting (Enable/Disable Extinguishing):</b>  |                         |                                 |
| • The “On/Off Exting” input is normally open.   | <b>1</b>                |                                 |
| <b>Potential outputs</b>  |                         |                                 |
| <b>➤ S 1 (Sounder 1) – Monitored:</b>   |                         |                                 |
| • Type  | potential relay         |                                 |
| • Electrical characteristics  | 24 VDC/ 0,5A            |                                 |
| <b>➤ S 2 (Sounder 2) – Monitored:</b>   |                         |                                 |
| • Type  | potential relay         |                                 |



|  |                                       |                     |
|--|---------------------------------------|---------------------|
| • Electrical characteristics                                 | 24 VDC/ 0,5A                          |                     |
| ➤ <b>EXT (Extinguishing, EN 12094-1) – Monitored:</b>        |                                       |                     |
| • Type   | potential relay                       |                     |
| • Electrical characteristics                                 | 24 VDC/1.5A 15min,<br>24 VDC/3A 100ms |                     |
| • Adjustable time triggering the output of 5 to 900 seconds. |                                       | <b>programmable</b> |
| <b>Relay outputs:</b>  |                                       |                     |
| ➤ <b>1 Stage Relay (FIRE STAGE 1) – Non-monitored:</b>       |                                       |                     |
| • Type   | potential-free                        | <b>NO</b>           |
| • Electrical characteristics                                 | 3A/125V AC,<br>3A/30V DC              |                     |
| ➤ <b>2 Stage Relay (FIRE STAGE 2) – Non-monitored:</b>       |                                       |                     |
| • Type   | potential-free                        | <b>NO</b>           |
| • Electrical characteristics                                 | 3A/125V AC,<br>3A/30V DC              |                     |
| <b>Non-monitored outputs, OC (Open Collector) type:</b>      |                                       |                     |
| ➤ <b>OK1 (Disabled mode selected Low Pressure event):</b>    |                                       |                     |
| • Electrical characteristics                                 | 30mA                                  |                     |
| ➤ <b>OK2 (Manual mode selected):</b>                         |                                       |                     |
| • Electrical characteristics                                 | 30mA                                  |                     |
| ➤ <b>OK3 (Low Pressure event):</b>                           |                                       |                     |
| • Electrical characteristics                                 | 30mA                                  |                     |
| ➤ <b>OK4 (Hold Activation event):</b>                        |                                       |                     |
| • Electrical characteristics                                 | 30mA                                  |                     |
| ➤ <b>Independent relay output in case of failure:</b>        |                                       |                     |
| • Quantity   | 1                                     |                     |
| • Type   | potential-free,<br>switching          | <b>NC / NO</b>      |
| • Electrical characteristics                                 | 3A/125V AC,<br>3A/30V DC              |                     |
| ➤ <b>Independent relay output in case of fire alarm:</b>     |                                       |                     |
| • Quantity   | 1                                     |                     |
| • Type   | switching                             | <b>NC / NO</b>      |
| • Electrical characteristics                                 | 3A/125V AC,<br>3A/30V DC              |                     |
| <b>POWER SUPPLY</b>  |                                       |                     |
| ➤ <b>Mains power</b>   |                                       |                     |
| • Voltage  | <b>(110-252)V AC</b>                  |                     |
| • Frequency  | <b>50/60 Hz</b>                       |                     |
| • Maximum power to mains power                               | <b>55W / AC</b>                       |                     |
| • Consumption from the main power supply in standby mode:    | <b>15 mA / 230V AC</b>                |                     |
| ➤ <b>Battery power</b>                                       |                                       |                     |
| • Battery quantity   | <b>2</b>                              |                     |

|  |                             |                                |
|--|-----------------------------|--------------------------------|
| • Type of the battery  | <b>Lead, gel</b>            |                                |
| • Battery rated voltage  | <b>12V DC</b>               |                                |
| • Rated power C20  | <b>5 (4.5)Ah</b>            |                                |
| • Internal resistance of the accumulator battery   | <b>Ri: &lt; 0.3Ω</b>        |                                |
| • Charger voltage  | <b>27,4 VDC</b>             | <b>temperature compensated</b> |
| <b>Consumption of battery power</b>  |                             |                                |
| • standby mode   | <b>&lt; 35 mA to 24 VDC</b> |                                |
| <b>Time needed in security mode when mains power supply is down with battery:</b>  |                             |                                |
| • 12V/ 5Ah   | <b>90h</b>                  |                                |
| <b>Executive devices powering</b>  |                             |                                |
| • Voltage  | <b>(19-27)V DC</b>          |                                |
| • Maximal current (including the controllable outputs current)   | <b>2A</b>                   |                                |
| <b>Fuses</b>   |                             |                                |
| • Mains power 230V AC  | <b>4,0 A fusible</b>        |                                |
| • Battery power  | <b>6,3 A fusible</b>        |                                |
| • Powering external devices  | <b>1,85 A automatic</b>     |                                |
| • Controllable outputs   | <b>1,1 A automatic</b>      |                                |
| <b>Functional characteristics</b>  |                             |                                |
| • Control of the lines, supervised balanced inputs and controllable outputs for fault conditions (short circuit and interruption) and automatic reset; |                             |                                |
| • Control of the lines for down fire detector and automatic reset;   |                             |                                |
| • Light and textual indication for Fire, Activated, Extinguish, Fault, Disable and Test mode;  |                             |                                |
| • Ability to delay controllable and general outputs for extinguishing for a period of 1 to 60 seconds after the registration of state Activated;       |                             |                                |
| • Built-in sounder in case of fire – monotonal, continuous with the possibility of exclusion;  |                             |                                |
| • Test mode of each (fire alarm) lines;  |                             |                                |
| • Ability to Disable each of the fire alarm lines;   |                             |                                |
| • Ability to Disable controllable output S 1 (Sounder 1);  |                             |                                |
| • LCD display, 2×16 characters and keyboard, for control and panel indication;   |                             |                                |
| • Energy independent archive of the events, recorded by the panel, consisting of type, date and time of the event - to 1900 events;                    |                             |                                |
| • Choice of language for text information display;   |                             |                                |
| • A set of test modes and options for adjustment of lines, outputs and panel.  |                             |                                |
| ➤ <b>Over all size</b>   |                             | <b>310x240x90 mm</b>           |
| ➤ <b>Weight without batteries</b>  |                             | <b>1,3 kg</b>                  |
| ➤ <b>Safety degree</b>   |                             | <b>IP30/ EN 60529</b>          |
| ➤ <b>Operation temperature:</b>  |                             | <b>minus 5°C up to +40°C</b>   |
| ➤ <b>Relative humidity</b>   |                             | <b>up to 95%</b>               |
| ➤ <b>Storage temperature</b>   |                             | <b>minus 10°C up to +60°C</b>  |
| <b>The panel meets standarts:</b>  |                             |                                |
| • EN12094:2003   |                             |                                |
| • EN 54-2:1997   |                             |                                |
| • EN 54-2:1997/A1:2006   |                             |                                |

|                            |
|----------------------------|
| • EN 54-2:1997/AC:1999     |
| • EN 54-4:1997             |
| • EN 54-4:1997/A1:2002     |
| • EN 54-4:1997/A2:2006     |
| • EN 54-4:1997AC:1999      |
| • EN 50130-4:2011          |
| • EN 55022:2006/A1:2007    |
| • EN 60950-1:2006/A11:2009 |







### **3. CONTROLS AND INDICATION**

#### ➤ **LED indicators**

| Indicators  |        | Function   |
|---|--------|--|
| <b>“POWER”</b>  | green  | Constant green light   |
| <b>“ACTIVATED”</b>  | red    | Blinking –Fire Stage 1 / Fire EN54-2<br>Lights ON - Fire Stage 2 / Activated EN12094   |
| <b>“RELEASED”</b>   | red    | Lights ON in case the release occurred. / Released EN12094   |
| <b>“FAULT”</b>  | yellow | A common failure indicator. Upon failure of any type a yellow light will start flashing  |
| <b>“SYS FAULT”</b>  | yellow | A system failure due to stoppage of the CPU. A constant yellow light will light up. Needs to be repaired at an authorized service.   |
| <b>“POWER FAULT”</b>  | yellow | In case of fault or loss of an AC or battery power supply a steady yellow light will light up.   |
| <b>“TEST”</b>   | yellow | When in line test condition a constant yellow light will light up.   |
| <b>“DISABLE”</b>  | yellow | When in Disabled component / line or controllable output / a steady yellow light will light up.  |
| <b>“OUTS”</b>   | yellow | Illuminates with steady yellow light at short or interruption of output devices power supply line  |
| <b>“DEL OUTS”</b>   | yellow | Continuous yellow light at preset delay of connected outputs   |
| <b>“BUZZER SILENCE”</b>  | red    | Indicator to the button "BUZZER SILENCE", in suppressing local buzzer, a steady red light will light up.   |
| <b>“SOUND SILENCE”</b>   | red    | Indicator to the button "SOUND SILENCE", when suppressing Fire outputs, a steady red light will light up.  |
| <b>“MANUAL”</b>   | yellow | The extinguishing process is manually operated only.   |
| <b>“DISABLE EXT”</b>  | yellow | The extinguishing process is disabled  |
| <b>“HOLD”</b>   | yellow | Lights ON in case of HOLD input has been operated  |
| <b>“AUTO”</b>   | yellow | The extinguishing process is automatic. In case of Fire Alarm Stage 2 the extinguishing process will run automatically or can be manually operated with pressing MANUAL RELEASE button on the front panel. |
| <b>“PRESOSTAT”</b>  | yellow | Lights ON in case of LOW PRESSURE input has been operated.   |
| <b>“FLOW CONTROL”</b>   | yellow | Lights ON in case of FLOW CONTROL input has been operated  |
| <b>“ELEKTRO VALVE”</b>  | yellow | Lights ON in case of the extinguishing output has been operated  |
| <b>“1 2 3”</b>  | red    | Individual indicators for Fire. Lights on permanently in case of fire alarm in line.   |

|         |        |   |
|---------|--------|---|
| "1 2 3" | yellow | Individual indicators for line failure. When disabled and line test there is an indication of the respective condition. |
|---------|--------|---|

➤ **BUTTONS**

| Button  | Panel condition                                      | Access level   | Действие на органа за управление  |
|---|--|----------------|---|
| <b>"RESET"</b><br>           | Fire, Activated                                      | Level 2        | Exit from Fire and Activated condition.   |
| <b>"SOUND SILENCE"</b><br>   | Fire, Activated                                      | Level 2        | Where activated outputs for Fire - silence of the same outputs.   |
| <b>"BUZZER SILENCE"</b><br> | Fire, Activated и Failure                            | All Levels     | Suppression / activation of the local sounder   |
|                            | Duty mode, Fire, Failure, Test and Disable component | Levels 1 and 2 | Entry in Information and management condition.  |
|   | Information and management                           | Levels 1 and 2 | - Displaying the next element onto the display;<br>- Moving of the cursor;<br>- Modification of the selected parameter.   |
|                            | Fire   | Levels 1 and 2 | - Displaying the previous text message for Fire onto the display.   |
|   | Information and management                           | Level 1 and 2  | - Displaying the previous element onto the display;   |
|   | Options  | Level 3        | - Modification of the selected parameter.   |
|                            | Fire   | Levels 1 and 2 | Displaying the next message for Fire onto the display   |
|   | Information and management                           | Levels 1 and 2 | - Displaying the next element from the menu onto the display;   |
|   | Options  | Level 3        | - Moving of the cursor;<br>- Modification of the selected parameter.  |
|                            | Information and management                           | Levels 1 and 2 | - Exiting a function without saving changes in parameter -no command execution;<br>- Exiting from the current menu and transition to the upper menu in the hierarchy. |

#### **4. DEFAULT PARAMETERS**

The fire panel provides users with default parameters, described in the table below. These parameters are saved and recorded from menu "Default par."

| <b><u>Fire Lines</u></b>                                  |                  |              |
|---|------------------|--------------|
| <b>➤ Current thresholds in the Fire lines:</b>            |                  |              |
| • Interruption  | from 4 mA        |              |
| • Duty mode   | from 5 to 16 mA  |              |
| • Fire  | from 17 to 99 mA |              |
| • Short circuit   | > 100 mA         |              |
| <b>➤ Lines' functional characteristics:</b>               |                  |              |
| • Verification quantity before entering in fire state:    | 2                | programmable |
| • Verification and registering fault in a earth conductor | On               | programmable |
| <b><u>Supervised balanced inputs</u></b>                  |                  |              |
| <b>➤ Manual Release:</b>                                  |                  |              |
| • The "Manual Release" input is:                          | normally open.   |              |
| <b>➤ Hold:</b>  |                  |              |
| • The "Hold" input is:                                    | normally open    | programmable |
| <b>➤ Low Press.:</b>                                      |                  |              |
| • The "Low Press." input is:                              | normally open    | programmable |
| <b>➤ Mode Select:</b>                                     |                  |              |
| • The "Mode Select" input is:                             | normally open    |              |
| <b>➤ On/Off Exting (Enable/Disable Extinguishing):</b>    |                  |              |
| • The "On/Off Exting" input is:                           | normally open    |              |
| <b><u>Potential outputs</u></b>                           |                  |              |
| <b>➤ EXT (Extinguishing, EN 12094-1):</b>                 |                  |              |
| • Time triggering the output:                             | 10 seconds       | programmable |
| <b><u>Functional characteristics</u></b>                  |                  |              |
| • Time for evacuation:                                    | 60 seconds       | programmable |

#### **5. PANEL INSTALATION AND SETUP**

##### **5.1 Panel assembly.**

- Unpack the panel;
- Mount the dowels at the appointed place for fixing the panel;
- Attach the panel to the dowels through the three holes on the chassis



It is recommended that the panel should not be installed near heat sources (radiators, air conditioners, etc.).

- The connecting wires are mounted, using the hole in the box.

## 5.2 A description of the PCB terminals

The FP9000E panel is mounted on a plastic chassis at the bottom of the panel. The connections to the main power unit, indication board and earth points are factory mounted. The connection wires for zones and control devices must be run out through the opening above the terminal rows. The terminals are designed to accept wires with cross section up to 2.5mm<sup>2</sup>. The wires must be fed from the upper side the terminals.

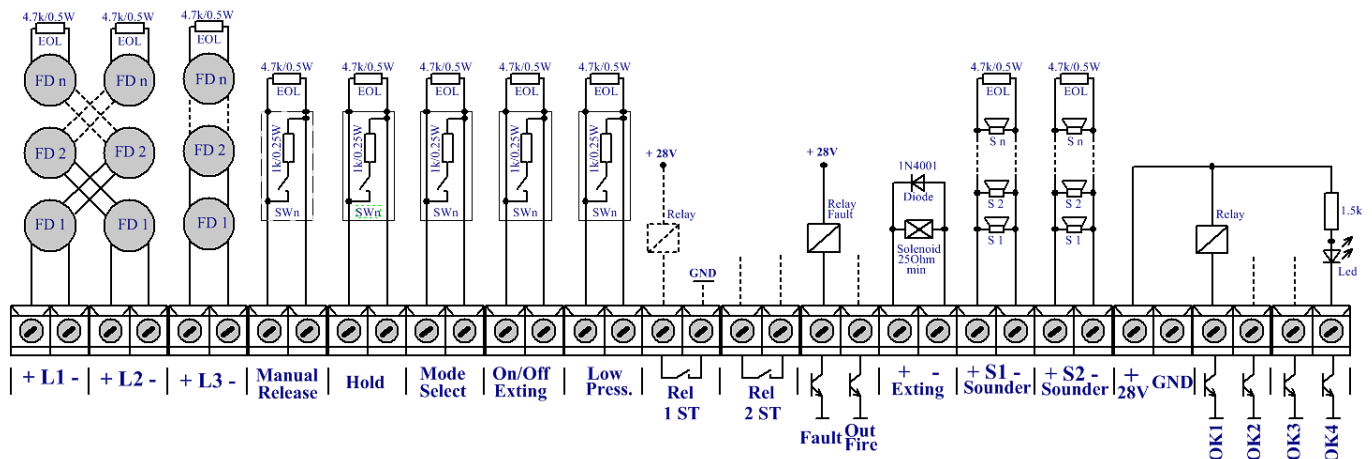

Fig.1

Description of the terminal row:

- **L1, L2** – Terminals for connecting the extinguishing zones, 2-wire cross-zoning connection of the detectors in the flooding area.
- **L3** – Terminal for connecting the fire alarm conventional zone, 2-wire connection of detectors and call points. This zone is only for fire alarm detection and signalization.
- **Manual Release** – Supervised balanced input. This input is used for sending a signal to the control panel (via call point) for starting the extinguishing in the protected area. More than one call point can be connected to this line.
- **Hold** - Supervised balanced input. This input is used for sending a signal to the control panel (via call point or a pressure switch) for holding (delaying) the extinguishing in the protected area. The active state of the input, NC (Normal closed) or NO (Normal open), can be configured through the panel setup menu.
- **Mode Select** - Supervised balanced input. This input is used for sending a signal to the control panel (via switch on/off contact) for the selected operation mode for the extinguishing. The operation modes are “Manual” and “Automatic”, as the “Manual” mode is selected when the switch is on, and the “Automatic” mode is selected when the switch is off.
- **On/Off Extng** - Supervised balanced input. This input is used for enabling/disabling of the extinguishing from an external device. The active state of the input, NC (Normal closed) or NO (Normal open), can be set via jumper J5.
- **Low Press.** - Supervised balanced input. This input is used for sending a signal to the control panel (from a pressostat contact, balance or other device) for monitoring the pressure level of the extinguishing agent (e.g. bottles, meaning that the gas from the bottle is released and the pressure

drops). The active state of the input, NC (Normal closed) or NO (Normal open), can be configured through the panel setup menu.

- **Rel 1ST (NO/COM)** – Dry contact relay output. The relay is activated in case of Fire Alarm Stage 1 operation mode.
- **Rel 2ST (NO/COM)** – Dry contact relay output. The relay is activated in case of Fire Alarm Stage 2 operation mode.
- **Fault** – Open collector output. The output is activated in case of fault in the control panel.
- **Fire** – Open collector output. The output is activated in case of Fire in the control panel.
- **Exting** (Extinguishing output, EN 12094-1) – Supervised output for activation of solenoid which starts the extinguishing automatics.
- **S 1** – Monitored sounder output. The output is activated in case of Fire Alarm Stage 1 detected in Zone 1 or Zone 2 or Zone 3
- **S 2** – Monitored sounder output. The output is activated in case of Fire Alarm Stage 2 detected in Zone 1 and Zone 2 – both zones are activated.
- **+ 28V / GND**, 1.0A. Auxiliary output for power supply of external devices.
- **OK1** – Open collector output. The output changes its state when the three-position key selector switch is set to “DISABLED” operation mode, or it activates input “ON/OFF Exting”. Both actions are about disabling the extinguishing process.
- **OK2** – Open collector output. The output changes its state when the three-position key selector switch is set to “MANUAL” operation mode.
- **OK3** – Open collector output. The output changes its state in case of “Low pressure” activation event.
- **OK4** – Open collector output. The output changes its state in case of “Hold” activation event.

### 5.3 Connecting Fire detectors.

➤ Line 1 and Line 2 are extinguishing zones. Use 2-wire cross-zoning connection of the detectors in the flooding area. The extinguishing in the protected area will start only when Line 1 AND Line 2 are activated and the panel is in Fire Alarm Stage 2 operation mode. The extinguishing process will not start if only Line 1 or Line 2 is activated. Line 3 is a conventional fire alarm zone. Use 2-wire connection of automatic fire alarm detectors and call point in the protected area. Activation of Line 3 starts Fire Alarm Stage 1 operation mode and activates the 1 Stage Relay output on the PCB control panel.

➤ **Fire detectors are installed** to the panel with the help of two-wire insulated line of total resistance up to 100Ω. The recommended conductor cross-section is depending on the length of the lines, which are:

Upon accession to the Fire alarm line to the panel, a check on the resistance is recommended. In case of proper installation in one line (fitted with finite element) between the plus and minus of the cable entering the panel, resistance should be measured 4,7k (+/-10%). When measuring the two wires to "Earth", there should not be a connection.

The connection is made to the terminals of the relevant modules - "+Lx" and "-Lx" (where "x" is the line number) when observing the indicated polarity. (Fig.2)

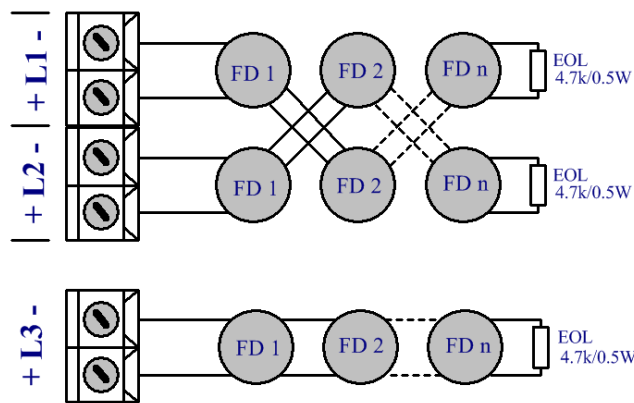

Fig.2

One line can allow the installation of up to 32 Fire detectors generally, regardless of their type.

To the unused lines, directly to the terminals mount the final element "EOL", otherwise the lines will be able in Fault condition.

➤ **FIRE LINES - Parameters programming and setting.**

For each Fire line individually, through the menus of the panel, there is an opportunity to set the following parameters:

- **Current interruption**

It can change the current interruption from 1 mA to 12 mA. The factory setting is 4 mA. The feature gives flexibility in installation of the panel, both existing installations and new, with sensors and final elements of any type.

- **Current Fire**

The limit current of Fire condition can be varied from 12 mA to 99 mA. The factory setting is 16 mA. The function enables the use of conventional Fire alarms detectors of any type and manufacturer.

- **Number of checks**

The setting provides a choice of 1, 2 or 3 checks before the line to enter the condition "Fire." The default setting is for 2 checks.

- When setting up with 1 check, panel enters Fire condition immediately after activation of the Fire alarm. This setting is recommended for lines with MCP.
- When setting up 2 alarms. After the first activation, the panel resets the line for 3 seconds and awaits a second response in the next 60 seconds. If there is a response in this period the panel enters Fire condition. This setting is recommended for lines with automatic Fire detectors the aim of ignoring false alarms.
- When setting up to 3 alarms. After the first activation, the panel resets the line for 3 seconds and awaits a second response in the next 60 seconds. If there is a response in this period, the panel again resets the line for 3 seconds and awaits for the third activation in the next 60 seconds, if any, the panel enters Fire condition. This setting is also recommended for lines with automatic fire detector for greater security when the Warning and extinguishing.

- **Inclusion of relay outputs in fire condition in the line.**

An additional relay module M9000R with 2/4/6/8 relays can be added to the panel, which can be configured in case of a fire alarm to the corresponding line.

### 5.4 Sounders Circuits Wiring

To every monitored output Sn could be connected several sounders – Fig.3. The maximum number of

sounders that could be connected in the circuit depends on their total current consumption, which must not exceed 0.5A.

Before connecting the last sounder in the circuit, parallel to it must be added resistor 4.7k. All connections are made by means of terminals, mounted on the printed circuit board.

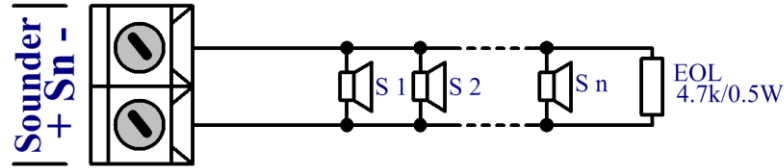

Fig. 3 - Connecting sounders to S n output

There is difference at activation of S 1 and S 2 sounder circuits output.

- S 1 circuit output is activated at Fire Alarm Stage 1 operation mode – any of the Zone 1, 2 or 3 is activated. The S 1 output is deactivated when S 2 output is activated – Fire Stage 2 operation mode is active.
- S 2 circuit output is activated at Fire Alarm Stage 2 operation mode, when:
  - Zone 1 and Zone 2 are activated;
  - The button Manual Release is manually pressed.

### 5.5 Connecting to the Supervised Inputs

The supervised inputs Manual Release, Hold, Mode Select, ON/OFF Extinguishing and Low Press are used for controlling the operation of the panel.

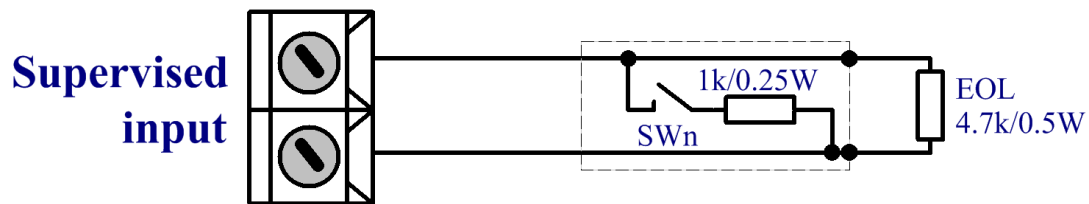

Fig. 4 – Connections to the supervised inputs

### 5.6 Solenoid Wiring – Connecting the Extinguishing Circuit

For normal (stand-by) operation mode, the Solenoid must have a resistance in the range (25-60) Ω. A suppression diode must be connected at the end of the solenoid circuit for preventing the electromagnetic field generated by the solenoid when it de-energizes from causing interference to the operation of the control panel.

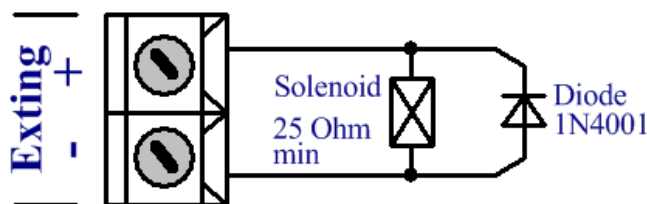
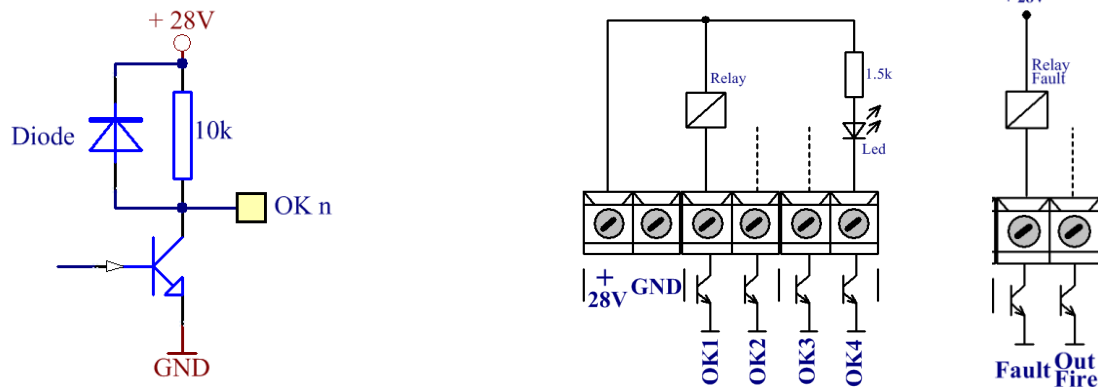

Fig. 5 – Example of wiring a solenoid

### 5.7 Connecting the OC Outputs

The open collector outputs are used for connecting external devices. The OC1, OC2, OC3, OC4, OutFire and Fault has same functionality and characteristics. The internal structure and an examples are shown on Fig. 6.



a) OC Internal circuit diagram

b) Examples for connecting Relay or LED

Fig. 6 – Connecting OC output circuits

### 5.8 Main Power Supply connection

The mains power supply of panel is realized with connection of the main power cable to the 230V terminal. To the terminal with mains fuse connect feeding cable observing the following positions.

- P - power wire " Phase";
- N - power wire " None ";
- "Earth" - safety ground wire.

The earth connection has to be realized in accordance with the rules for the electrical safety with the total resistance in the circuit lower than 10Ω. It is mandatory to connect the main power supply cable to the middle input of the fire panel terminal

The cable should be double insulated and section not less than 0,5 mm<sup>2</sup> for power cables and 1,5 mm<sup>2</sup> for the safety ground wire.

The other end of the feeding cable is connected to the mains using a junction box.

The mains power supply of the panel should be on a separate circuit.

The main power unit has a LED for indication of a power presence. The LED is lighting on in green in all cases when the panel has main (~230VAC) and/or back-up (2x12VDC) power supply.

### 5.9 Connection of Back-up Batteries

The accumulator battery leads are mounted on a terminal at the bottom of main control panel. The back-up power supply of panel is realized with two batteries 12VDC/5Ah (4.5Ah). Use the 100mm cable from the spare parts kit (with red and black cable shoes) to connect the batteries in series and after than observing the polarity connect the battery leads from the main PCB - see Figure 10.

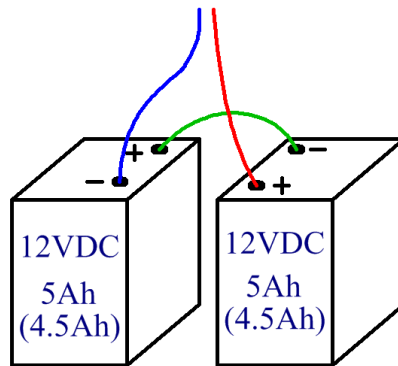

Fig. 7 – Serial connection of the batteries

## **6. PUTTING THE PANEL IN WORKING CONDITION**

- Check the connection to mains power supply.
- Check the correct connection of peripheral devices.
- Place the fuse in the terminal.
- Join the feeding cables to the batteries, where as the batteries are connected in series. To the positive terminal of the battery join the red wire and the negative – to the blue wire. The overall voltage of both batteries must be greater than 17,6 V, otherwise the panel does not recognize them. Thermal sensor in the panel place in the battery. With it you monitor the temperature and control the mode battery charge.
- If everything is done correctly and the lines parameters are within the factory settings, the panel enters Duty Mode.
- Do a check of current in all lines from the "Electricity lines" menu from the main menu. The standby current is recommended to be from 2mA to 5mA set over the current interruption.  
*Example: The factory settings are with current interruption 4 mA, when a measurement of current in standby condition is done, line is recommended to be from 6 mA to 9 mA.*  
 If using linear, non-standard and other Fire alarms detectors, it is necessary to adjust the currents break and Fire, so that the panel can be able to recognize them correctly.
- Set the accession of exits and the respective delays, if they are necessary.
- If necessary, program and adjustment to other parameters of the panel and the lines from the respective menus. The programming of parameters can be done before connecting the wires of lines and outputs.
- If necessary, adjusts the clock for real-time of the panel.
- Reset archive events.

## **7. LEVELS OF ACCESS**

In panel FP9000E there are **4 LEVELS** of access to the various indications and control functions.

### ➤ **Access Level 1**

This level of access is for all persons, whom can be expected to identify and react to Fire alarm, Activated or fault. Visible are all light indicators.

Available are the following features:

- suppression of built sounder;
- displaying suppressed messages for Fire, Activated, Fault and Disabled components;
- displaying the status of the lines;

### ➤ **Access Level 2**

This is a level of access to persons, who are responsible for the safety and are trained and authorized to operate the panel in the conditions:

- Security;
- Activated;
- Fire;
- Fault;
- Disabled component;
- Test.

In access level 2 are available are following features:

- Exit from Fire and Activated condition;
- suppression of the outputs, activated when Fire and Activated;
- involuntary activation of the controllable outputs;
- suppression of built- in sounder.

Switching from **Level 2 to Level 1 and vice versa** happens after a combination of buttons and the relevant information on the display.

The selection happens from the second menu of the main menu - " Access Level ".

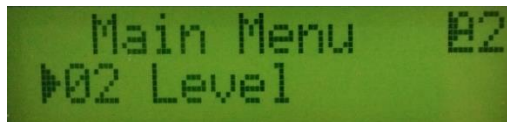

After entering the menu, with button «Enter» and the corresponding buttons up and down choose the level. Confirm again with «Enter».

The selected level, in Security/Duty mode, is displayed in the upper right corner of the display.

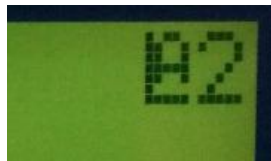

### ➤ Access level 3

In Level 3 is reached by entering a password and opening the front cover of the panel.

Available are the following panel's features:

- all possibilities from Levels 1 and 2;
- Replacing a burnt fuse;
- Configure from menu settings of all parameters.

### ➤ Access Level 4

This is the level of access for persons who are trained and authorized by the manufacturer to repair the panel and modify the software.

Special means are required to enter this level.

## 8. OPERATION MODES

### 8.1. Normal Operation Mode



The extinguishing panel is in normal operation mode (stand-by) when only the LED “POWER ON” on the front power is lighting on in green. The internal buzzer and all other status LEDs are off. The key for selection of the extinguishing mode is set to Automatic, Manual or Disabled position.

### 8.2. Fire Alarm Stage 1 /Fire EN54-2/

The extinguishing panel goes to Fire Alarm Stage 1 operation mode when a fire alarm is generated from a detector or call point in only one of the fire zones – Zone 1, Zone 2 or Zone 3.

During Fire Alarm Stage 1 operation mode are activated.

- The sounder output S1 and the internal buzzer.
- The Fire Stage 1 Relay output.
- The FIRE LED (red) of the Zone detected fire and ACTIVATED LED is blinking in red on the front panel.

The User can stop the signalization of the internal buzzer by pressing the SILENCE BUZZER button. The S1 output can be suppressed by pressing the SILENCE SOUNDERS button – the yellow LED lights on.

The extinguishing process can be manually started by pressing the MANUAL RELEASE button on the front panel if the mode selector for the extinguishing is set to MANUAL or AUTOMATIC position.

### 8.3. Fire Alarm Stage 2 /Activated EN 12094/

The extinguishing panel goes to Fire Alarm Stage 2 if one of the following events are following in sequence:

- Fire Alarm Stage 1 operation mode activated by Zone 1 and a second fire alarm from Zone 2 is generated.
- Fire Alarm Stage 1 operation mode activated by Zone 2 and a second fire alarm from Zone 1 is generated.
- Fire Alarm Stage 1 operation mode activated by Zone 3 and fire alarms from Zone 1 AND Zone 2 are generated.
- The panel is in normal operation mode and the MANUAL RELEASE button on the front panel is pressed (the mode selector for the extinguishing is set to MANUAL or AUTOMATIC position).

During Fire Alarm Stage 2 operation mode are activated:

- The sounder output S2 and the internal buzzer.
- The Fire Stage 2 Relay output.
- The FIRE LED (red) of the Zones detected fire and the ACTIVATED LED lights on in red on the front panel.
- The Evacuation time starts running counting down the time left to starting the extinguishing on the site. The ACTIVATED LED lights on in red.
- The extinguishing devices are activated – the RELEASED LED lights on in red.

**The S2 output cannot be silenced.** The user can only stops the signalization of the internal buzzer by pressing the SILENCE BUZZER button.

Pressing of HOLD button (connected to supervised input HOLD on the main PCB) will reset the evacuation time.

### 8.4. Extinguishing

The extinguishing is a process for releasing of extinguishing agents via special automatic devices in case of fire alarm in the protected premises.

The extinguishing process can be started automatically at any time with pressing the MANUAL RELEASE button on the front panel when the mode selector for the extinguishing is set to MANUAL or AUTOMATIC position.



The extinguishing in the site starts after Fire Alarm Stage 2 is over and the set EXTINGUISHING DELAY TIME is out. Then the “Exhting” output on the PCB is activated for a preset EXTINGUISHING DURATION TIME.

During Extinguishing operation mode are activated:

- The Evacuation time starts running counting down the time left to starting the extinguishing on the site. The ACTIVATED LED lights on in red.

- The extinguishing devices are activated – the RELEASED LED lights on in red.

- The “Exhting” output is activated.

The operation of the panel in Extinguishing mode is necessary to program the respective system times.

## 8.5. Fault

The extinguishing panel goes to Fault mode in case of fault condition in the system– short or open circuit, main or back-up power supply lost, CPU error, etc.

During FAULT mode are activated:

- The internal buzzer with a beeping signal.

- The Fault output.

- **LED indication** – lights up the indicator : "FAULT" and depending on the fault :
  - Upon System error - indicator "SYS FAULT" lights up in continuous yellow light;
  - Upon fault in Fire alarm line - individual fault indicator flashes yellow light respectively when:
    - short circuit - with a frequency of 1 Hz ( slow flashing );
    - interruption - a frequency of 4 Hz ( fast flashing );
  - Upon fault in a controllable output - indicator "OUTS" lights up with flashing yellow light;
  - Upon fault in mains supply - indicator "POWER FAULT" lights up in continuous yellow light;
  - Fault in the local network or the transmission device - indicator "COMUN" lights up with a steady yellow light.
  - If the sound signal is suppressed by button "BUZZER SILENCE", LED indicator lights up a constant red light.
- **Beeper indication** – The built-in sounder is activated with a discontinuous signal.
- **Text messages indication** - Text messages for fault condition are displayed by priority on the main display screen.

If we have more than one failure, by button  and regulating buttons enter the menu "FAULT". In this menu you can see all registered damage.

- **Active buttons**
  - button "BUZZER SILENCE". Pressing it leads to:
    - **disabling** the embedded sounder S1, if it is activated by Fire;
    - **activating** the built-in sounder, if the panel is in Fire or Fault condition and the annunciator is disabled by previous pressing the same button.
  - Button  When you press it, the panel enters Information and Control condition.

## 8.6. Disabled component condition

Panel enters **Disabled component** condition after a manual operation of disabling a specific component - a Fire alarm line and/or controllable output S1. The condition is managed through the information and control screens. The menu «Disable» is third from the main menu.

After selecting the relevant line and/or controllable output with buttons, switch the conditions

"on" and "off", respectively for disabled function on and off.

The forbidden line is off (not supplied) and it is not controlled for activated Fire alarm and Fault. The disabled controllable output is switched off (the executive device can not be activated) and is not monitored for failure.

- **LED indication** - light indicators:
  - "DISABLE" lights up with a constant yellow light
  - "1 2 3" local line indicator lights up with flashing yellow light.
  - "S 1" flashes when a disabled controllable output.
- **Beeper indication** - not affected by the disabled component condition.
- **Text messages indication** - Information about the lines and controllable outputs in Disabled, are displayed on the display. When "on" we have a disabled component in "off" active.

## 8.7 Test condition

Panel enters Test condition through manual operation for setting a Fire alarm line in to test. The condition is managed through screens of Information and control condition. Menu «**Test Lines**» is fourth from the main menu.

After selecting the respective line, with the button switch conditions "on" and "off", respectively, on and off Test function.



When inserting the line test, the following changes are in effect:

Upon registration of Fire event in the line, sound and light indications and associated controllable and relay output for failure are not activated, ie the panel does not enter Fault Condition:

- Events in the line are not saved in the energy independent archive;
- The line is reset (shuts off its power supply for time 3sec) automatically every 60s.
- **LED indication** - light up indicators:
  - "TEST" is lit with yellow light
  - "1 2 3" local line indicator in Test lights up with flashing yellow and red light.
- **Beeper indication** - is not affected by the of the Test condition lines.
- **Text messages** - Information on the lines in Test are displayed on the display. When "on" we have a line in Test and when "off" - no line in Test.

### 8.7.1. Test leds

#### **Testing of LED indication the panel done by menu «Test indication».**

With button  activate the illumination of all LEDs. The exception is the indicator for systemic failure that should not be on. With button  start the test. If button  is not pressed, the panel automatically enters Duty condition after 30 seconds.

## **9 INFORMATION AND CONTROL CONDITION**

The panel has a display and keyboard to check the parameters, settings, monitoring and changing conditions, displaying archives of events and etc. From the menus can be selected more than 50 active screens for setup and management of the panel.

By menus you can perform the following actions:

**Main menu:** /access level 1 or 2/

- View all the zones in Fire;
- View all the failures;
- Change the access level from 1 to 2 and vice versa;
- Review and launch (at access level 2) of the Disable condition;
- Review and launch (at access level 2) of the Test in line condition;
- Review of current current in the Fire alarm lines.

**System features:** /Access Level 2/

- Test indication;
- Setup the real-time clock, year, month, day, hour, minute, second, correction;
- View the archive of events; /up to 1600 events/

**Setting:** /Access level 2 + password/

- Setup the parameters of the panel : Language, Network address and on / off function to check for ground wire failure;
- Lines' Setting. For each line we have separate settings: Electricity interruption, Electricity of Fire, Number of checks to enter the condition Fire On. / Off. ;
- Adjustment of extinguishing functions: Time Evacuacia, Time Extinguish Valve, Setup input Hold, Setup input Low pressure;
- Input factory settings menu;
- Change the password to access the setup menu;
- Delete archive.

**! When working with menus to have the following characteristics.**

- When working with menus, use the four active buttons for information and management. (see Controlsfor management and indication).
- If you enter into the menu,s structure and has no activity for more than 30 seconds, it automatically returns to Duty mode.
- If you can not enter into a menu, check whether the access level is set properly.
- Please note that Setting Mode stops processing the Fire alarm lines.
- After exiting from the Setup menu the panel goes through reset and record the new set parameters.

**10. DELIVEERY COMPOSITION AND COMPLEXITY/SET**

|                                    |                |
|------------------------------------|----------------|
| • Fire Station FP9000E             | <b>1 qty.</b>  |
| • EOL - resistor 4,7kΩ/0,6W:       | <b>10 qty.</b> |
| • Resistor 1,5kΩ(1kΩ)/0,25W:       | <b>5 qty.</b>  |
| • Fuse 6,3A;                       | <b>1 qty.</b>  |
| • Fuse 4,0A;                       | <b>1 qty.</b>  |
| • Connective bridge for batteries; | <b>1 qty.</b>  |
| • Packaging.                       | <b>1 qty.</b>  |

**11. WARRANTY**

The manufacturer guarantees the product's conformity with EN 12094, EN 54-2: 1997, A1: 2006, EN54-4: 1997, A1: 2002, A2: 2006. The warranty period is 36 months from the date of sale, provided that:

- the conditions of storage and transport were met;
- the startup has been done by authorized persons;
- The requirements for operation conditioned in this instruction were met;
- Defects are not caused by natural phenomena and accidents of the plug socket.

*DMTech wishes you splendid work!*

**For any questions may contact the company's technical staff DMTech, by email.**

*e-mail*     [office@dm-teh.com](mailto:office@dm-teh.com)